

ARBOLES UK LTD

Unit 56 · Flexspace Business Centre · Manchester Road · Bolton · BL3 2NZ
T: +44 (0)1204 388814 F: +44 (0)1204 388813

sales@arboles.co.uk www.arboles.co.uk

DATE

October 2020

DIMENSIONS IN MILLIMETERS
MAY VARY BY ± 10 mm

Product Dimensions

SIZE
DIN A4

SCALE
1 : 20



REF.
4220 SS

Floor Mounted Emergency Shower and Eyewash

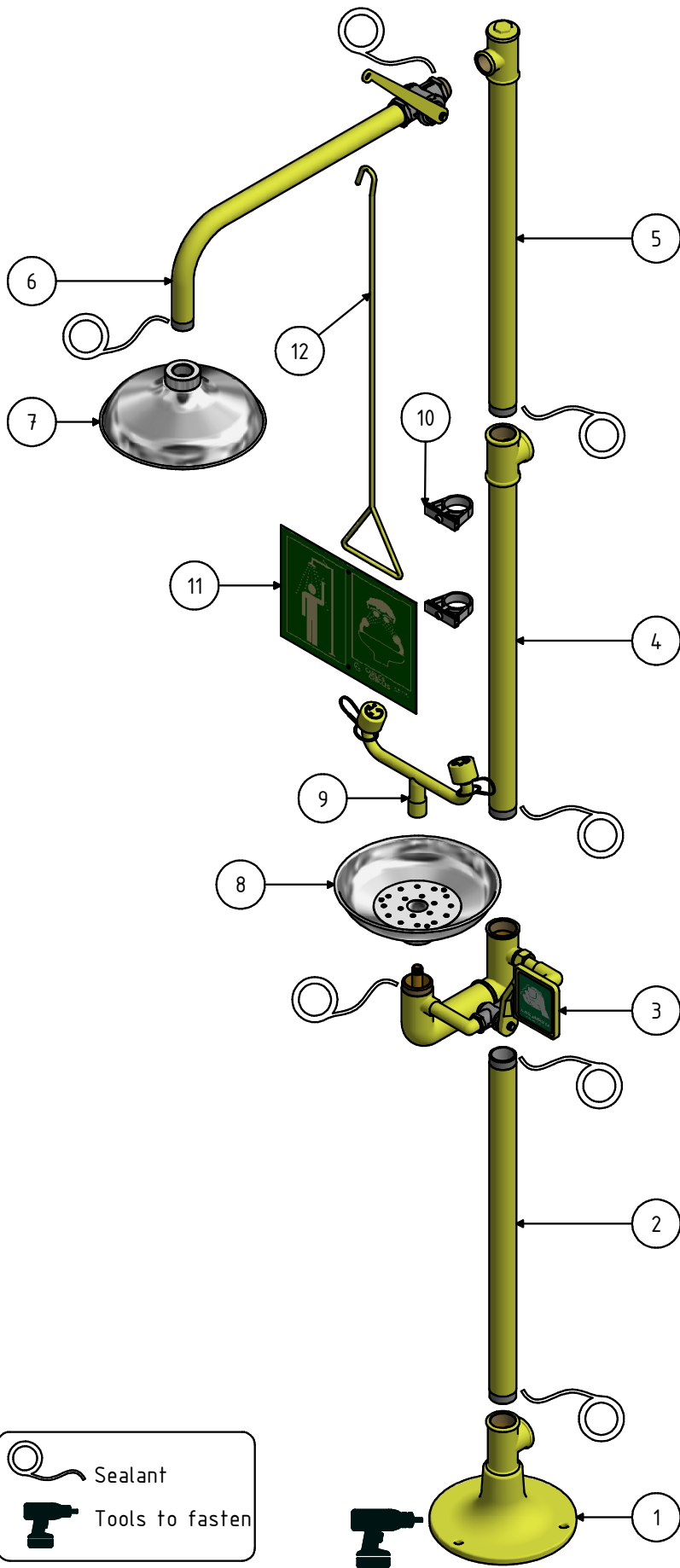

Item	Qty	Ref.	Descr.
1	1	180030	SUPPORT ASSEMBLY
2	1	864650	PIPE 1-1/4" x 650 mm
3	1	180135	EYEWASH BLOCK ASSEMBLY
4	1	180125	MIDDLE PIPE ASSEMBLY
5	1	180120	UPPER PIPE ASSEMBLY
6	1	180075	SHOWER ARM ASSEMBLY
7	1	192100	STAINLESS STEEL SHOWER HEAD
8	1	191150	STAINLESS STEEL BOWL
9	1	190136	EYE WASH 'BULL HORN' HEAD ASSEMBLY
10	1	191007	SIGN FIXING KIT
11	1	191006	SHOWER AND EYEWASH SIGN
12	1	190105	SHOWER PULL ROD

ARBOLES UK LTD

Unit 56 · Flexspace Business Centre · Manchester Road · Bolton · BL3 2NZ
 T: +44 (0)1204 388814 F: +44 (0)1204 388813

sales@arboles.co.uk www.arboles.co.uk

DATE

October 2020

Installation Diagram

SIZE
DIN A4

SCALE
1 : 10

REF.
4220 SS

Floor Mounted Emergency Shower and Eyewash



ARBOLES UK LTD

LABORATORY TAPS, SAFETY SHOWERS AND EYE WASHES

Trace Heating & Insulation Installation Instructions

This guide applies to the following models:

4220 AW 4250 AW

4220 & 4250 (When retro fitting)

1110 AW

1110 (when retro fitting)

N.B: The shower should already be assembled and installed prior to the fitting of the trace heating and insulation

Step 1 – Trace Heating cable installation

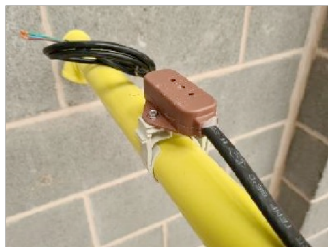

Mount the pre-wired thermostat onto the inlet pipe utilising one of the pipe clamps included with the shower assembly (the inlet pipe is not included).

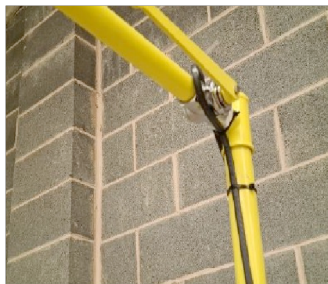

Run the trace heating cable along the inlet pipe and turn through 90 degrees vertically up the pipe to the top shower valve, the electrical cable should be looped around the valve as shown and secured using tie wraps or PVC tape (not included)

Care should be taken not to kink or cut the electrical cable. Ensure the cable is run close and flush to the metal surfaces as shown. Do not run the cable out to the shower head.

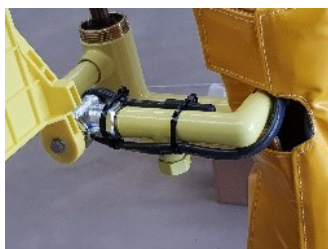

Loop the cable around the valve & back down the opposite side of the pipe to the eyewash valve as shown. Run the cable along the eyewash inlet piping and loop around the valve. Terminate as shown. Depending on where the thermostat is mounted will depend on where the heating cable finishes, ensure the eyewash valve has heating cable around it and complete the heating cable installation by securing the pre sealed end to the pipework. Again, secure the heating cable as previously stated.

ARBOLES UK LTD

Unit 56 • Flexspace Business Centre • Manchester Road • Bolton • BL3 2NZ

T: 0044 (0)1204 388814 F: 0044 (0)1204 388813

sales@arboles.co.uk www.arboles.co.uk



ARBOLES UK LTD

LABORATORY TAPS, SAFETY SHOWERS AND EYE WASHES



Finish cable installation should be as per image.

Electrical connection should only be carried out by a suitably qualified person. See separate sheet for electrical specification.

ARBOLES² UK LTD

Unit 56 • Flexspace Business Centre • Manchester Road • Bolton • BL3 2NZ
T: 0044 (0)1204 388814 F: 0044 (0)1204 388813

sales@arboles.co.uk www.arboles.co.uk



ARBOLES UK LTD

LABORATORY TAPS, SAFETY SHOWERS AND EYE WASHES

Step 2 – The Installation of the High Visibility Lagging and Jacket

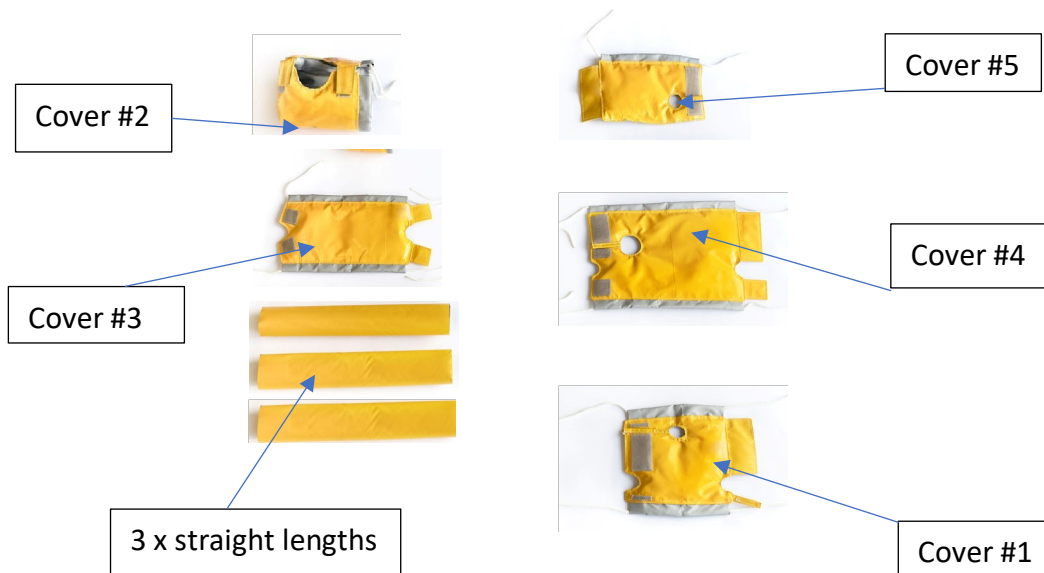

Install the 3 pre-assembled straight lengths of yellow foam insulation using the Velcro fastenings onto the straight large diameter upright pipe lengths, as shown.

Please note, there are two sizes of foam, two pieces of the same size to fit over the heating taped sections & one to fit over the bottom section drainpipe.

ARBOLES UK LTD

Unit 56 • Flexspace Business Centre • Manchester Road • Bolton • BL3 2NZ
T: 0044 (0)1204 388814 F: 0044 (0)1204 388813

sales@arboles.co.uk www.arboles.co.uk



ARBOLES UK LTD

LABORATORY TAPS, SAFETY SHOWERS AND EYE WASHES

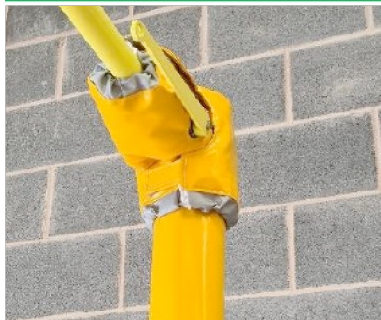

Starting from the top, fit the valve cover #1 onto the shower valve securing with the Velcro flaps & side drawcords. Cover #2 will fit over the Tee section at the top adjacent to cover #1. Ensure the upright foam lagging is inside the drawcords joint before tying securely.



Cover #3 will fit over the main upright tubing of the shower at the horizontal inlet tee, again fasten with the Velcro flaps and drawcords.



Cover #4 fits around the eyewash valve and inlet pipework it has two holes in the cover, it should be positioned as the image on the left, to ensure correct orientation around the eyebath valve.

Fit cover #5 to the main tee section of the vertical pipe work ensuring correct fitment with cover #4 before final positioning of the Velcro and tightening the drawcords.

Finally, visually ensure all the joints conceal the internal pipework and electrical cables to ensure maximum thermal efficiency of the installation.

Adjust Velcro as required after a week or so.

ARBOLES UK LTD

Unit 56 • Flexspace Business Centre • Manchester Road • Bolton • BL3 2NZ
T: 0044 (0)1204 388814 F: 0044 (0)1204 388813

sales@arboles.co.uk www.arboles.co.uk



ARBOLES UK LTD

LABORATORY TAPS, SAFETY SHOWERS AND EYE WASHES

Information on the thermostat:

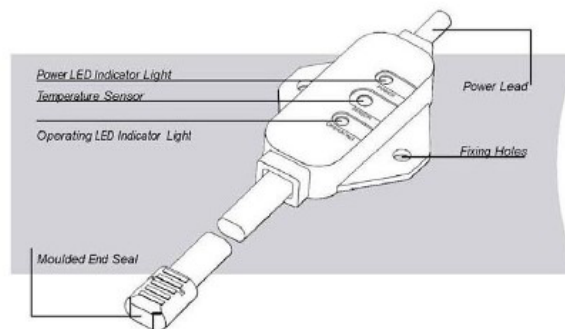

- Supplied ready terminated with inline moulded thermostat
- Switches on at 0°C and switches off at 3°C
- Self regulation and temperature control provides safety with maximum energy efficiency
- 230v with IP65 rated components
- Available in various lengths

ARBOLES⁵ UK LTD

Unit 56 • Flexspace Business Centre • Manchester Road • Bolton • BL3 2NZ
T: 0044 (0)1204 388814 F: 0044 (0)1204 388813

sales@arboles.co.uk www.arboles.co.uk